

Det 5. Bracket Modul Solar Cell
SCALE 1 : 25

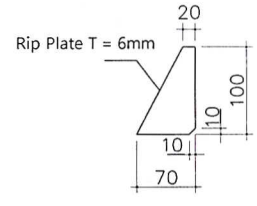

Det. Rip Plate
SCALE 1 : 25

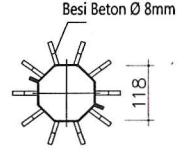

Det 2. Klem Anti Panjang
SCALE 1 : 25

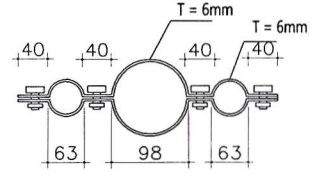

Det 4. Klem Ornamen
SCALE 1 : 25

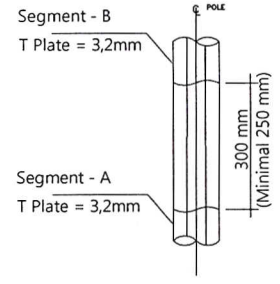

Det 3. Slip Joint
SCALE 1 : 25

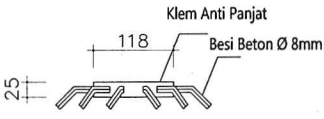

Det 2. Klem Anti Panjang
SCALE 1 : 25

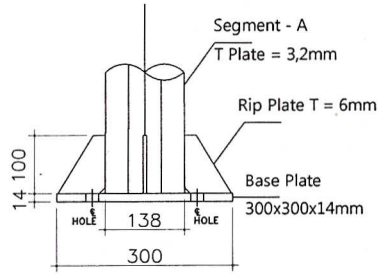

DET. 1 Base Plate
SCALE 1 : 25

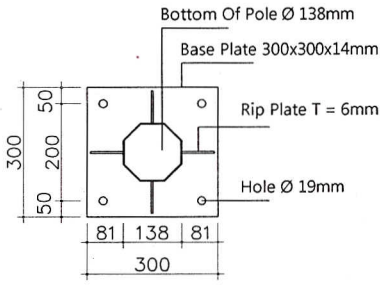

DET. 1 Base Plate
SCALE 1 : 25

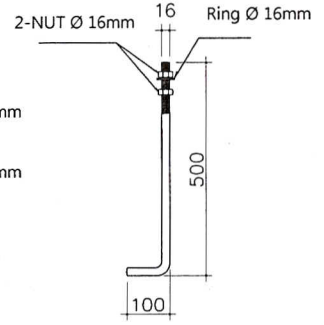

Det. Anchor Bolt
SCALE 1 : 25

TIANG PJU H-07M DP TYPE SC
SCALE 1 : 100
OCTAGONAL

KETERANGAN

STANDART MUTU :

- ISO 9001 : 2008
- Plate Baja : ST 41 / SS 400
- Welding : Las Listrik
- Finishing Hot Dip Galvanize
- Segment System Slip Joint
- Segment A = 4000mm
- Segment B = 3300mm
- Bottom Of Pole Ø 138mm
- Base Plate 300x300x14mm

PRODUCTION :

JOB TITLE :

TECHNICAL SPECIFICATION

CLIENT :

TOTAL :

DRAWING TITLE :

TIANG PJU OCTAGONAL
H-07M DP TYPE SOLAR CELL

DATE	CLIENT APPROVAL	APPROVAL
CAD	DESIGN	CHECK
Auto CAD 2009	Dwi. Y	Efi
DRAWING NO : HELORI-H07-DP-SC	SHEET NO : SHEET 1 Of 1	