

Det 3. Bracket Modul Solar Cell
SCALE 1 : 25

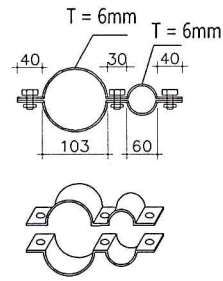

Det 4. Klem Ornament Lampu
SCALE 1 : 25

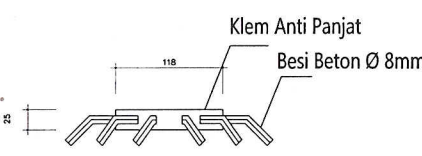

Det 2. Klem Anti Panjang
SCALE 1 : 25

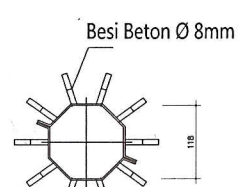

Det 2. Klem Anti Panjang
SCALE 1 : 25

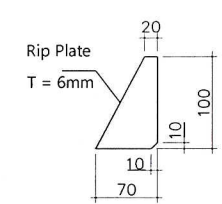

Det. Rip Plate
SCALE 1 : 25

TIANG PJU H-09M SP TYPE SC
OCTAGONAL

SCALE 1 : 100

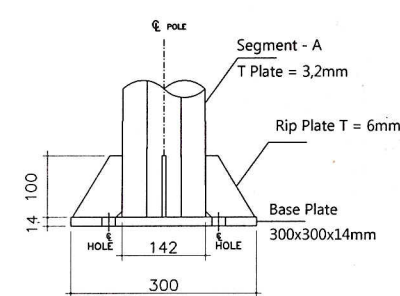

Det 1. Base Plate
SCALE 1 : 25

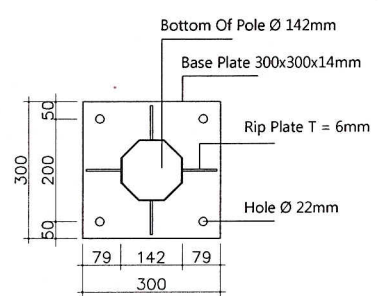

Det 1. Base Plate
SCALE 1 : 25

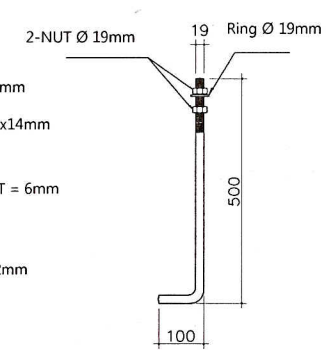

Det. Anchor Bolt
SCALE 1 : 25

KETERANGAN

STANDART MUTU :

- ISO 9001 : 2008
- Plate Baja : ST 41 / SS 400
- Welding : Las Listrik
- Finishing Hot Dip Galvanize
- Segment System Slip Joint
- Segment A = 6000mm
- Segment B = 3300mm
- Bottom Of Pole Ø 142mm
- Base Plate 300x300x14mm

PRODUCTION :

JOB TITLE :

TECHNICAL SPECIFICATION

CLIENT :

TOTAL :

DRAWING TITLE :

**TIANG PJU OCTAGONAL
H-09M SINGLE PARABOLE**

DATE	CLIENT APPROVAL	APPROVAL

CAD	DESIGN	CHECK
Auto CAD 2009	Dwi. Y	Efi

DRAWING NO :	SHEET NO :
HELORI-H09-SP-SC	SHEET 1 Of 1